



Features

- Constant voltage PWM style output with frequency up to 4KHz design compliant IEEE1789-2015 no risk
• Bluetooth Mesh Dimming Function
• Plastic housing with class II design
• Built-in active PFC function
• Class 2 power unit
• Fully encapsulated with IP67 level
• Typical lifetime>50000 hours and 5 years warranty

Applications

- LED strip lighting
• Indoor LED lighting
• LED decorative lighting
• LED architecture lighting
• Type "HL" for use in Class I, Division 2 hazardous (Classified) location.
• Intelligent lighting control

GTIN CODE

MW Search: https://www.meanwell.com/serviceGTIN.aspx

Description

PWM-60 IoT series is a bluetooth ready 60W LED AC/DC LED driver featuring the constant voltage mode with PWM style output, which is able to maintain the brightness homogeneity when driving all kinds of LED strips and constant voltage LED bulbs. PWM-60 IoT operates from 90~305VAC and offers models with different rated voltage ranging between 12V and 48V. Thanks to the high efficiency up to 90%, with the fanless design, the entire series is able to operate for -20°C ~ +85°C case temperature under free air convection. The entire series is rated with IP67 ingress protection level and is suitable to work for dry, damp or wet locations. PWM-60 IoT is designed with dimming function that varies the duty cycle of the output, providing great flexibility for LED strips applications.

Model Encoding

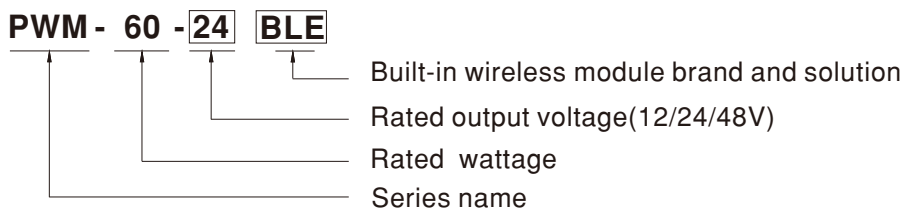

IoT wireless Module brand and solution

Table with 4 columns: Brand, Solution, Wireless standard, Note. Rows include Casambi (BLE), Tuya (TY1), and Silvair (SVA).

**SPECIFICATION**

MODEL		PWM-60-12□	PWM-60-24□	PWM-60-48□
OUTPUT	DC VOLTAGE	12V	24V	48V
	RATED CURRENT	5A	2.5A	1.25A
	RATED POWER	60W	60W	60W
	PWM FREQUENCY (Typ.)	up to 4kHz		
	SETUP, RISE TIME <small>Note.2</small>	1000ms,80ms/115VAC or 230VAC for BLE and TY; 2000ms,80ms/115VAC or 230VAC for SVA		
	HOLD UP TIME (Typ.)	16ms/115VAC or 230VAC		
INPUT	VOLTAGE RANGE <small>Note.3</small>	90 ~ 305VAC 127 ~ 431VDC (Please refer to "STATIC CHARACTERISTIC" section)		
	FREQUENCY RANGE	47 ~ 63Hz		
	POWER FACTOR (Typ.)	PF>0.97/115VAC, PF>0.95/230VAC, PF>0.92/277VAC @ full load (Please refer to "POWER FACTOR (PF) CHARACTERISTIC" section)		
	TOTAL HARMONIC DISTORTION	THD< 20% (@load≥60%/115VAC, 230VAC; @load≥75%/277VAC) (Please refer to "TOTAL HARMONIC DISTORTION" section)		
	EFFICIENCY (Typ.)	86%	89%	90%
	AC CURRENT (Typ.)	0.8A / 115VAC	0.4A / 230VAC	0.32A / 277VAC
	INRUSH CURRENT (Typ.)	COLD START 50A(twidth=270μs measured at 50% Ipeak) at 230VAC; Per NEMA 410		
	MAX. NO. of PSUs on 16A CIRCUIT BREAKER	9 units (circuit breaker of type B) / 16 units (circuit breaker of type C) at 230VAC		
	LEAKAGE CURRENT	<0.25mA / 277VAC		
	NO LOAD POWER CONSUMPTION	<1W		
PROTECTION	OVERLOAD	108 ~ 130% rated output power Hiccup mode, recovers automatically after fault condition is removed		
	OVER VOLTAGE	15 ~ 17V	28 ~ 34V	54 ~ 60V
	OVER TEMPERATURE	Shut down o/p voltage, re-power on to recover		
ENVIRONMENT	WORKING TEMP.	Tcase=-20 ~ +85°C (Please refer to "OUTPUT LOAD vs TEMPERATURE" section)		
	MAX. CASE TEMP.	Tcase=+85°C		
	WORKING HUMIDITY	20 ~ 95% RH non-condensing		
	STORAGE TEMP., HUMIDITY	-40 ~ +80°C, 10 ~ 95% RH		
	TEMP. COEFFICIENT	±0.03%/°C (0 ~ 50°C)		
	VIBRATION	10 ~ 500Hz, 5G 12min./1cycle, period for 72min. each along X, Y, Z axes		
FUNCTION	WIRELESS PROTOCOL	Bluetooth low energy 2.4GHz protocol		
	DIMMING RANGE	0 ~ 100% Minimum dimming level:1%, dim to off		
	WIRELESS DISTANCE	Up to 20m		
	DIMMING <small>Note.10</small>	Please refer to "DIMMING OPERATION" section		
SAFETY & EMC	SAFETY STANDARDS <small>Note.5</small>	UL8750 (type "HL" ), UL879 (for 12V,24V Blank Type only), CSA C22.2 No. 250.13-12; ENEC BS EN/EN61347-1, BS EN/EN61347-2-13 independent, BS EN/EN62384, BIS IS15885 (for 12,24,48 Blank Type only), EAC TP TC 004, Ip67 (except for BLE type), GB19510.1, GB19510.14 approved; Design refer to BS EN/EN60335-1		
	WITHSTAND VOLTAGE	I/P-O/P:3.75KVAC		
	ISOLATION RESISTANCE	I/P-O/P:100M Ohms / 500VDC / 25°C / 70% RH		
	EMC EMISSION <small>Note.6</small>	Compliance to BS EN/EN55015, BS EN/EN61000-3-2 Class C (@load≥60%) ; BS EN/EN61000-3-3, GB/T 17743, GB17625.1,EAC TP TC 020		
	EMC IMMUNITY	Compliance to BS EN/EN61000-4-2,3,4,5,6,8,11; BS EN/EN61547, light industry level (surge immunity Line-Line 2KV),EAC TP TC 020		
OTHERS	MTBF	2938.9K hrs min. Telcordia SR-332 (Bellcore) ; 299.8K hrs min. MIL-HDBK-217F (25°C)		
	DIMENSION	150*53*35mm (L*W*H)		
	PACKING	0.49Kg;30pcs/15.7Kg/1.0CUFT		

**NOTE**

- All parameters NOT specially mentioned are measured at 230VAC input, rated current and 25°C of ambient temperature.
- De-rating may be needed under low input voltages. Please refer to "STATIC CHARACTERISTIC" sections for details.
- Length of set up time is measured at first cold start. Turning ON/OFF the driver may lead to increase of the set up time.
- The driver is considered as a component that will be operated in combination with final equipment. Since EMC performance will be affected by the complete installation, the final equipment manufacturers must re-qualify EMC Directive on the complete installation again.  
(as available on [https://www.meanwell.com/Upload/PDF/EMI\\_statement\\_en.pdf](https://www.meanwell.com/Upload/PDF/EMI_statement_en.pdf))
- This series meets the typical life expectancy of >50,000 hours of operation when Tcase, particularly (Tc) point (or TMP, per DLC), is about 75°C or less.
- Please refer to the warranty statement on MEAN WELL's website at <http://www.meanwell.com>
- The ambient temperature derating of 3.5°C/1000m with fanless models and of 5°C/1000m with fan models for operating altitude higher than 2000m(6500ft).
- For any application note and IP water proof function installation caution, please refer our user manual before using.  
[https://www.meanwell.com/Upload/PDF/LED\\_EN.pdf](https://www.meanwell.com/Upload/PDF/LED_EN.pdf)
- When the power is turned on at -40°C, it may enter the pairing mode.
- The dimming memory function needs at least 5 seconds to complete.
- The matching mode of TY1 type is on-off-on-off-on by AC or DC power.
- To fulfill requirements of the latest ErP regulation for lighting fixtures, this LED power supply can only be used behind a switch without permanently connected to the mains.

※ Product Liability Disclaimer : For detailed information, please refer to <https://www.meanwell.com/serviceDisclaimer.aspx>

## ■ DIMMING OPERATION

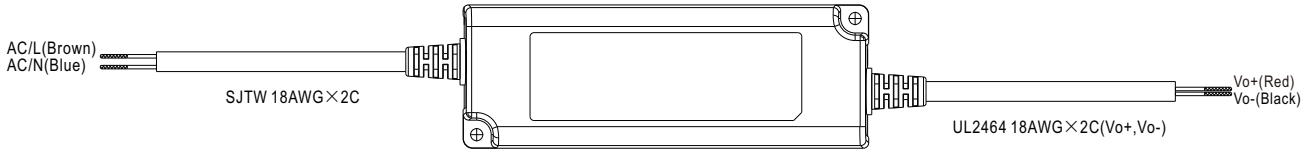

### ※ Dimming principle for PWM style output

- Dimming is achieved by varying the duty cycle of the output current.

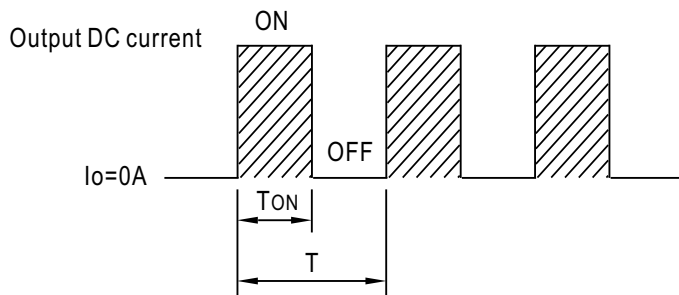

$$\text{Duty cycle(\%)} = \frac{T_{ON}}{T} \times 100\%$$

Output PWM frequency : up to 4KHz

### ※ Bluetooth control

- To be used through APP available on Apple Store and Google Play Store for iOS and Android.  
Search: BLE with Casambi/TY1 with Smart Life/SVA with Silvair  
Example:



The APP for BLE type is "Casambi"    The APP for TY1 type is "Smart Life"    The APP for SVA type is "Silvair"

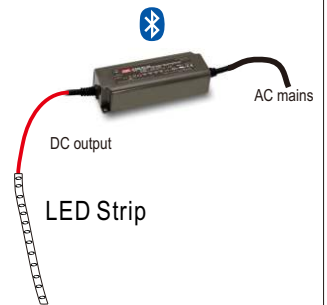
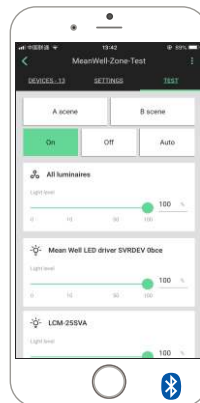
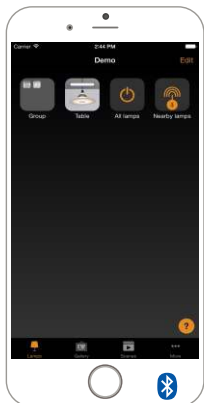

**OFFICIAL WEBSITE AND ECOSYSTEM INFORMATION****CASAMBI**

The real time Bluetooth IC temperature is shown in the APP. In case it reaches above 77 °C (equivalent to Tc 85°C), the driver will be turn off to provide a protection. In case the units is cooled down, it can be manually turn ON and back to normal operation again.

NOTE: 1.This software temperature protection is an extra independent function from driver its own hardware over temperature protection(when it is enabled, it needs re-AC power on to recover).

2.In general the software temperature protection is triggered before the hardware one when in over temperature.

3.Website: <https://www.casambi.com>



NOTE: 1.Website: <https://www.tuya.com>

**SILVAIR**

NOTE: 1.Website: <https://www.silvair.com>

### OUTPUT LOAD vs TEMPERATURE

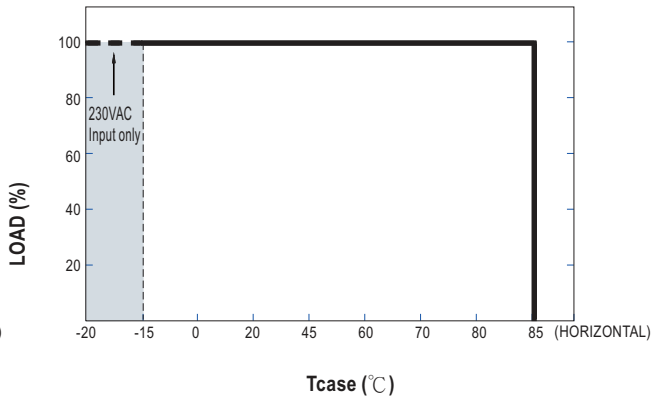
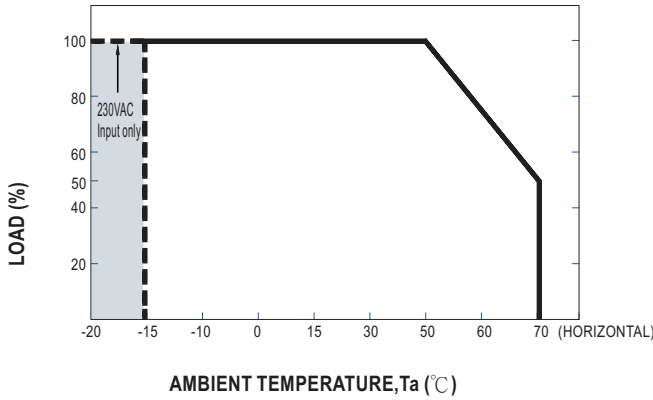

### STATIC CHARACTERISTIC

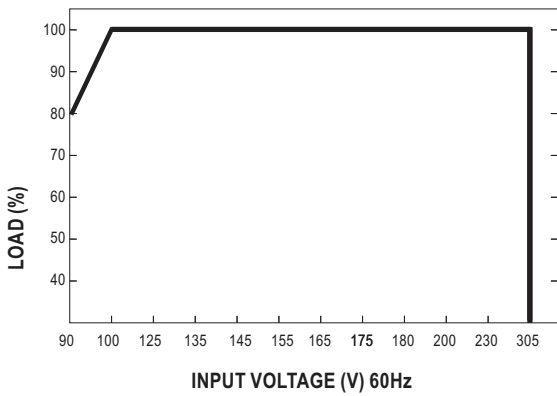

※ De-rating is needed under low input voltage.

### POWER FACTOR (PF) CHARACTERISTIC

※  $T_{case}$  at 75°C

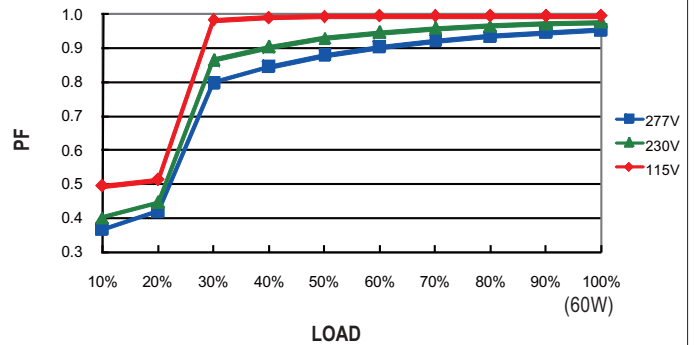

### TOTAL HARMONIC DISTORTION (THD)

※ 48V Model,  $T_{case}$  at 75°C

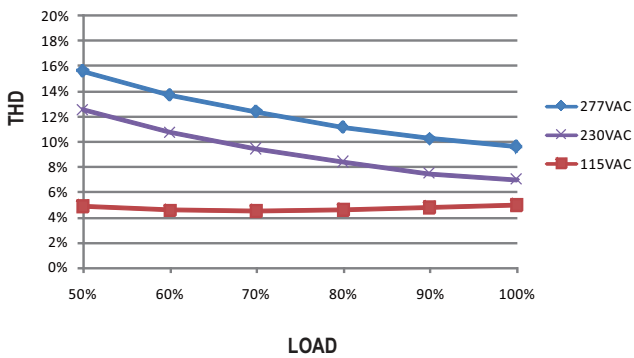

### EFFICIENCY vs LOAD

PWM-60 series possess superior working efficiency that up to 90% can be reached in field applications.

※ 48V Model,  $T_{case}$  at 75°C

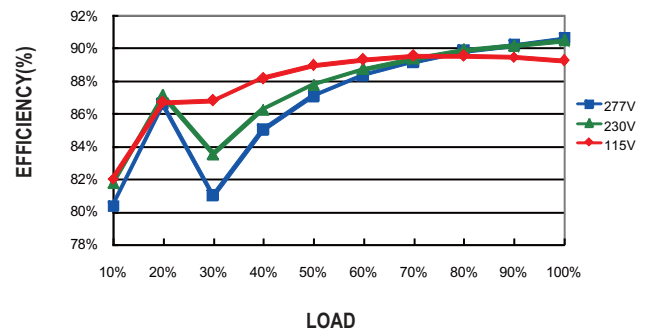

■ LIFE TIME

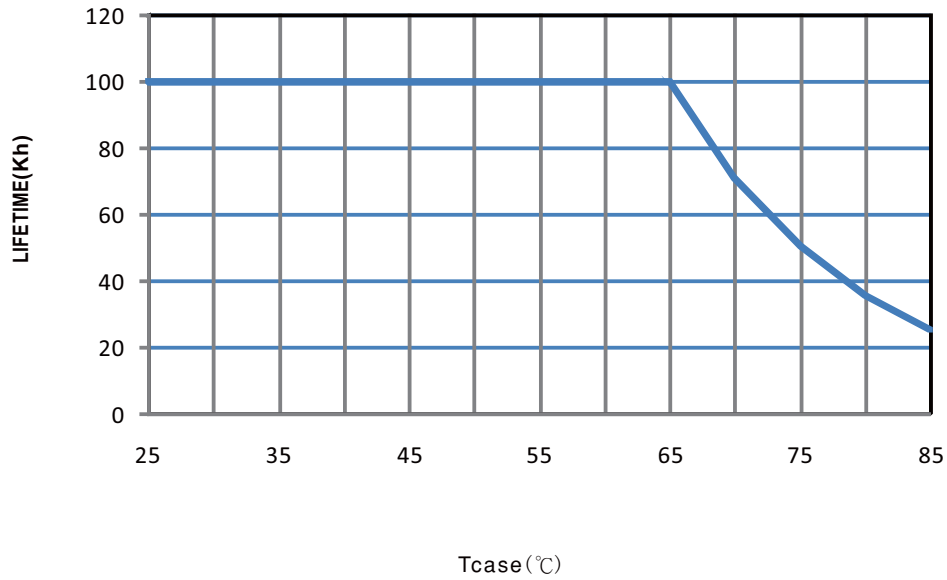

■ Bluetooth mesh LED driver for intelligent lighting Application

**PWM-60/90/120/200 Series**

**Multi-Dimming Function LED Driver and Wireless IoT Solutions**

- 0-10V
- PWM
- Resistance
- Push Dimming
- DALI / DALI 2.0
- KNX
- Bluetooth Mesh
- WiFi.....and so on

Building Lighting with Bluetooth Mesh Solution

3rd Party APPs, APP, Gateway Return, APP

## Block Diagram

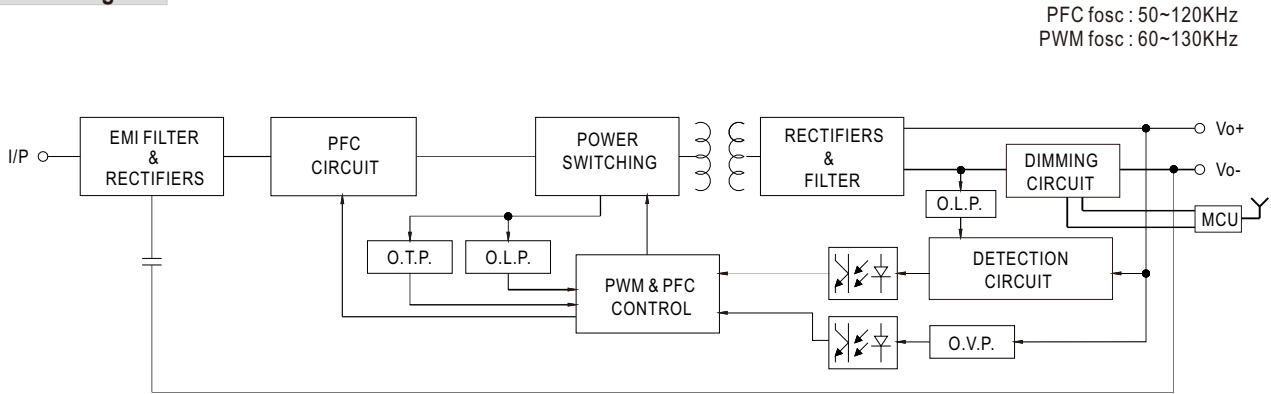

## Mechanical Specification

Case No. PWM-60 Unit:mm Tolerance:±1

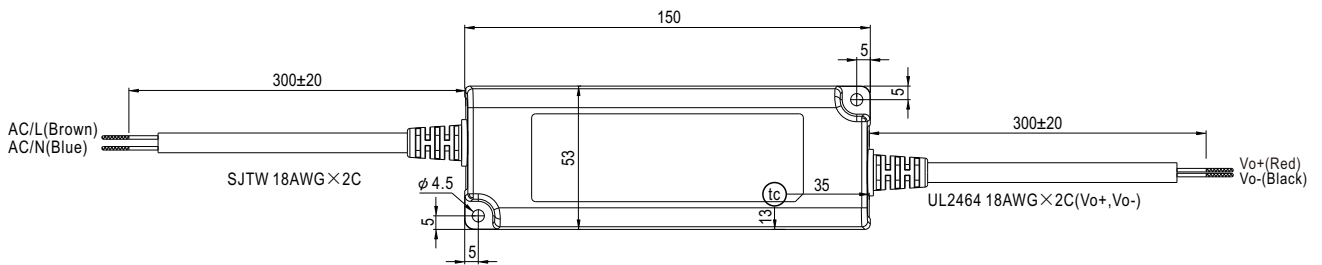

• (tc) : Max. Case Temperature < 85°C

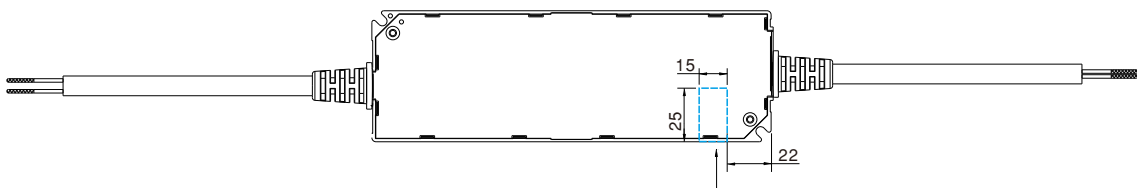
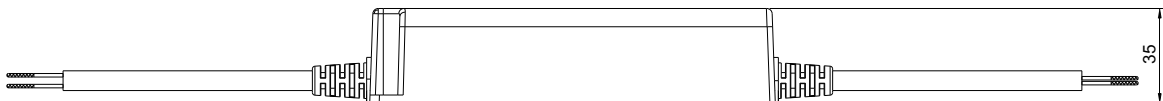

The position of antenna  
Keep it free from metal or  
any material that stops RF signal

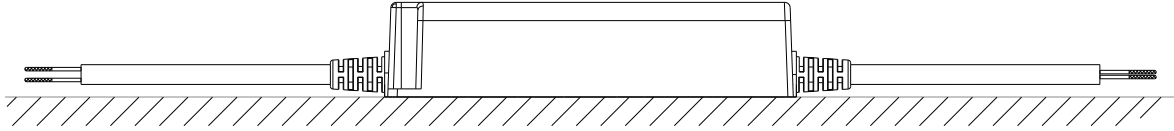
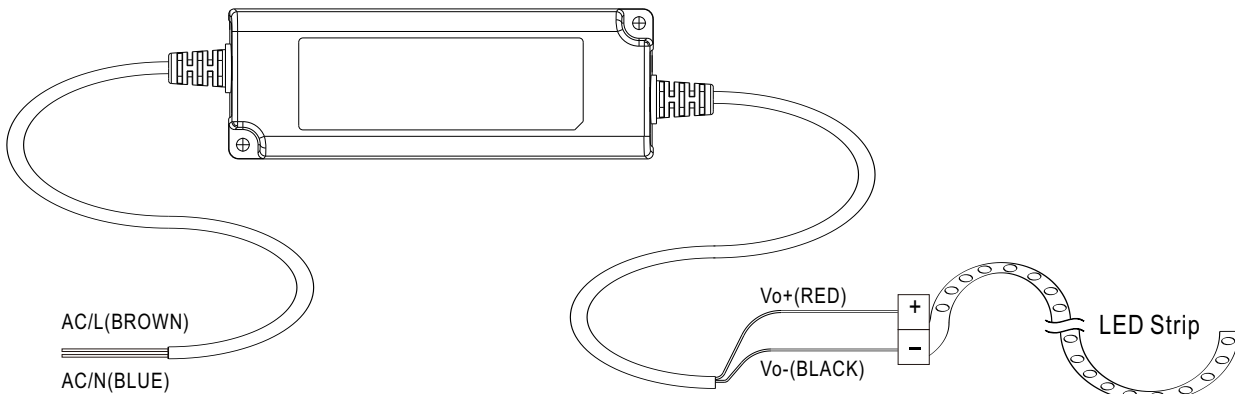
**■ Recommend Mounting Direction****■ Installation Manual****◎ Connection for Blank-type****◎ Cautions**

- Before commencing any installation or maintenance work, please disconnect the power supply from the utility. Ensure that it cannot be re-connected inadvertently!
- Keep proper ventilation around the unit and do not stack any object on it. Also a 10-15 cm clearance must be kept when the adjacent device is a heat source.
- Mounting orientations other than standard orientation or operate under high ambient temperature may increase the internal component temperature and will require a de-rating in output current.
- Current rating of an approved primary /secondary cable should be greater than or equal to that of the unit. Please refer to its specification.
- For LED drivers with waterproof connectors, verify that the linkage between the unit and the lighting fixture is tight so that water cannot intrude into the system.
- For dimmable LED drivers, make sure that your dimming controller is capable of driving these units. PWM series require 0.15mA each unit.
- Tc max. is identified on the product label. Please make sure that temperature of Tc point will not exceed limit.
- Suitable for indoor use or outdoor use without direct sunlight exposure. Please avoid immerse in the water over 30 minutes.
- The power supply is considered as a component that will be operated in combination with final equipment. Since EMC performance will be affected by the complete installation, the final equipment manufacturers must re-qualify EMC Directive on the complete installation again.