

COB LED Strip Datasheet

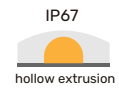

Product: COB-296LED-8MM-AC

- 296chips, 80lm/W, dot-free
- 110V/220V, no need extra driver
- 180 degree beam angle
- CRI80+, for decorative lighting

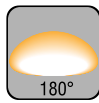

Sizes:

FYX08T296G

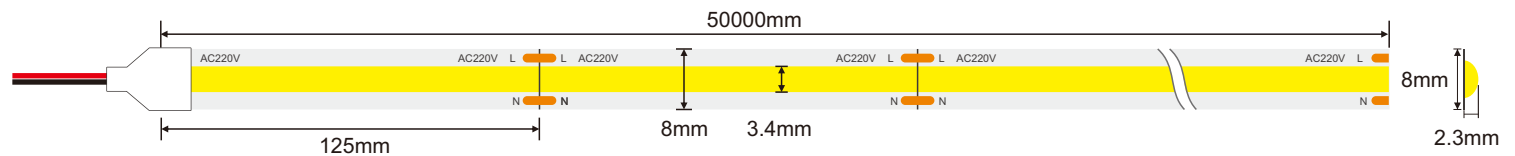

Parameters:

Model NO.	FYX08T296G	Efficacy	>80lm/W
Input Voltage	AC110V/220V	Beam Angle	180°
Power	10W/m	Cut Section	125mm
LED QTY	296LEDs/m	Dimension	50000*8*2.3mm
CCT	2700K-6500K	IP Rating	IP20/IP67
SDCM	≤5	Warranty	2 Years
CRI	>80	Package Info	L22*W22*H26cm(500m/Box)

Accessories Available:

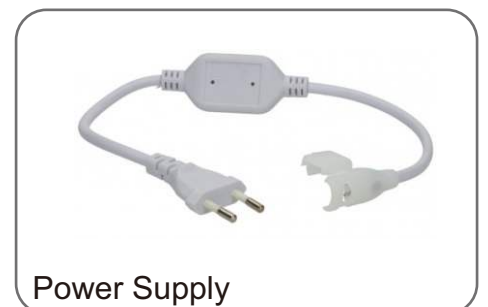
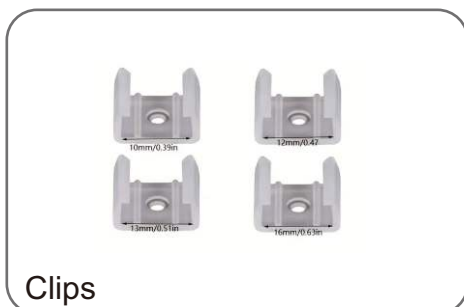

Installation:

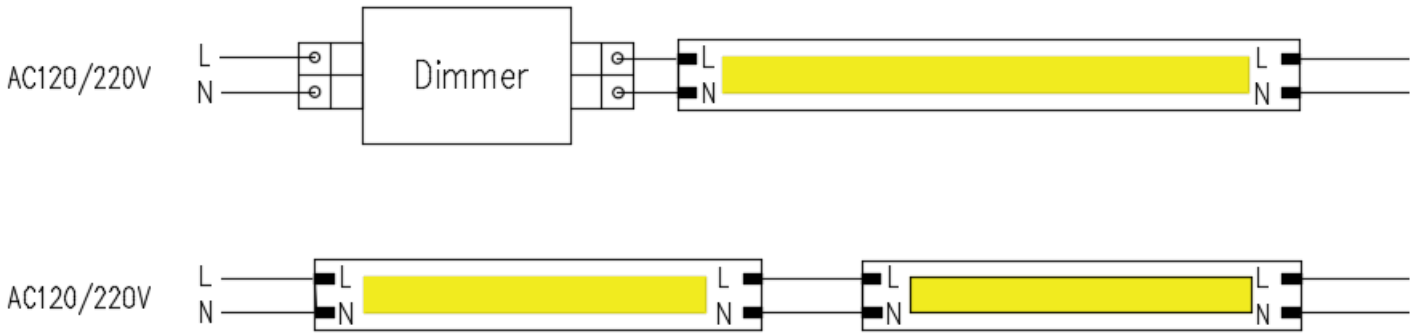

LED Strip Installation Steps:

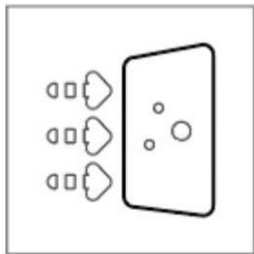

Clean the surface of object



Cutting

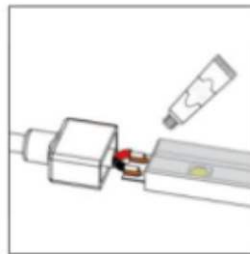

Seal the strip

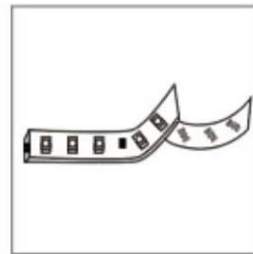

Stick the strip



Power the strip

Pay Attention:



high temperature surrounding



power led strip with reel



object surface with oil, dust and silicone



strip fold

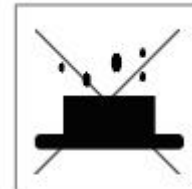

dirty on the surface of LED

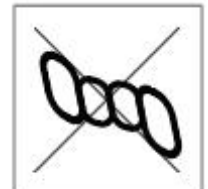

twist the strip

Packing:



5m/Reel

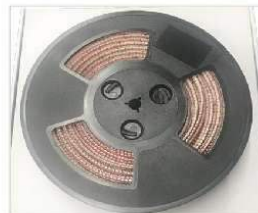

20m/Reel



50m/Reel



Shipping



Outer carton



Inner carton